



# World Pressure Filters

The Standard in 7,000 psi Pressure Filters



ENGINEERING YOUR SUCCESS.

# WPF Series

## Applications

Parker engineers have developed what soon will be the industry standard in high pressure hydraulic filtration. The new 7,000 psi WPF series incorporates many advanced features designed for one reason: to improve your bottom line.

There is no better high pressure filter available today for durability and performance. The reduction of your operating costs is our primary concern, and we are committed to contributing towards your success.

### Typical Applications

- **Aircraft Ground Support**
- **Injection Molding**
- **Mining**
- **Mobile Ag**
- **Mobile Construction**
- **Oil & Gas Exploration**
- **Power Generation**
- **Primary Metals**
- **Refuse Trucks**



# WPF Series

## Features



# WPF Series

## SurgeGuard Elements

Proprietary  
SurgeGuard protection  
System protection  
from back-flow

Component performance  
integrity with improved flow fatigue  
resistance

Integrated bypass & reverse flow  
valve technology  
Every element serviced provides  
new bypass &  
reverse flow valve assembly

Reliable, high performance, quick  
response design

Low mass, low  $\Delta P$   
reverse flow valve  
Ideal for closed-loop  
applications

Greater design and  
service flexibility

Patented  
deformable tangs  
Automatic element  
locate and removal

Easy, fast, safe, clean

Element removal  
clearance  
Benchmarked best-in-class  
against major competitors

Ease-of-service.  
Machine design flexibility

Patented valves  
with low hysteresis  
Zero leakage  
and low friction

Optimum performance

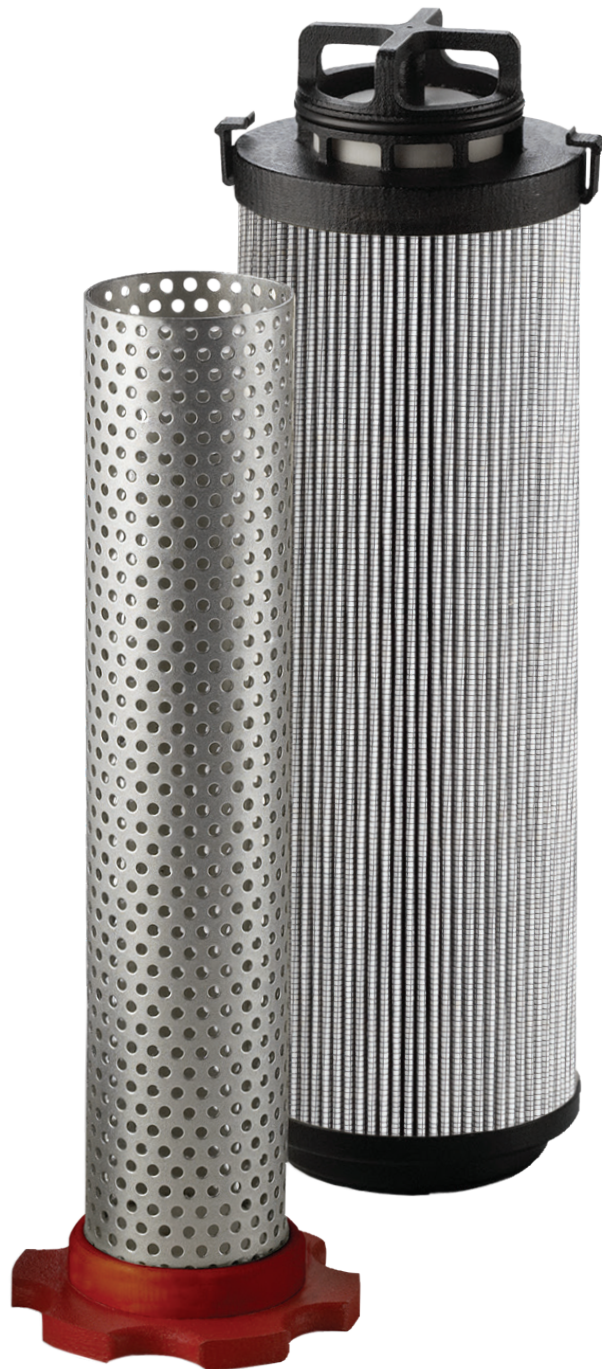

# WPF Series

## WPF1 Element Performance

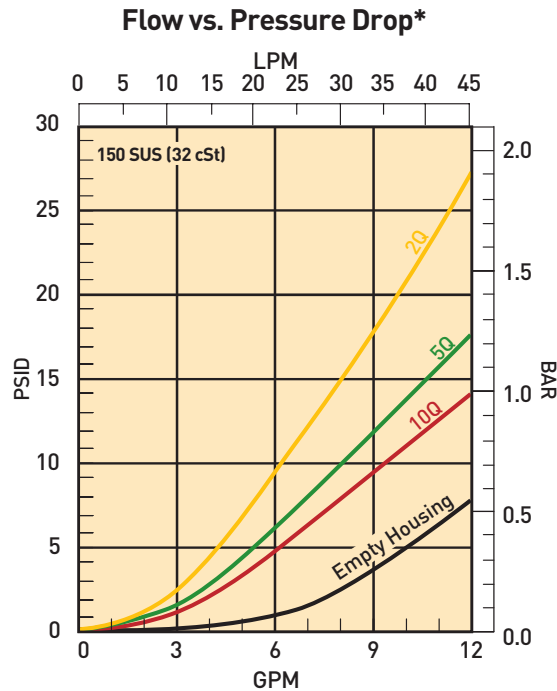
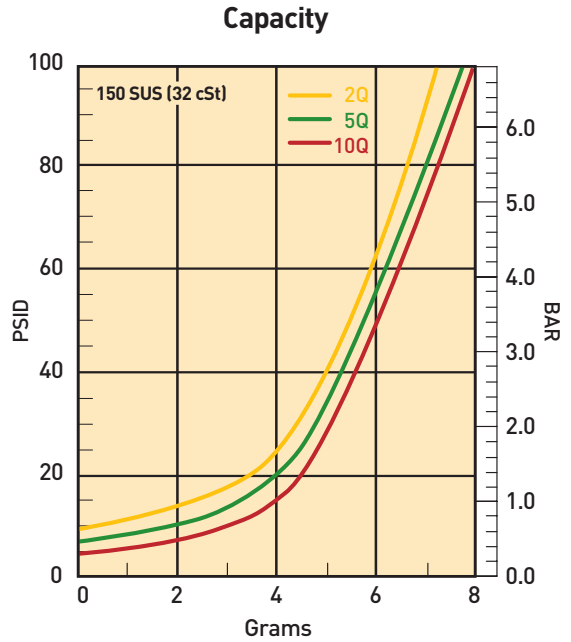
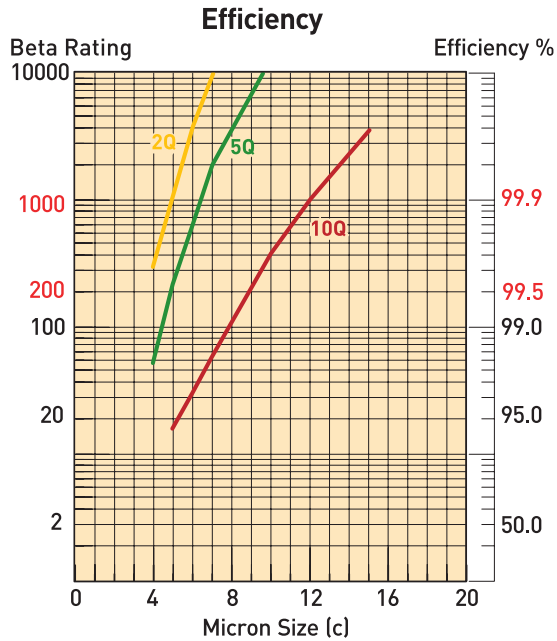

\*High Collapse Correction Factor:  
 "QH" Elements (2000 psid) = 1.4 times reported loss

Results typical from Multi-pass tests run per test standard ISO 16889 @ 10 gpm to 50 psid terminal - 10 mg/L BUGL.

Note: During reverse flow, ΔP is 20 psid at max. flow.

# WPF Series

## WPF2 Element Performance

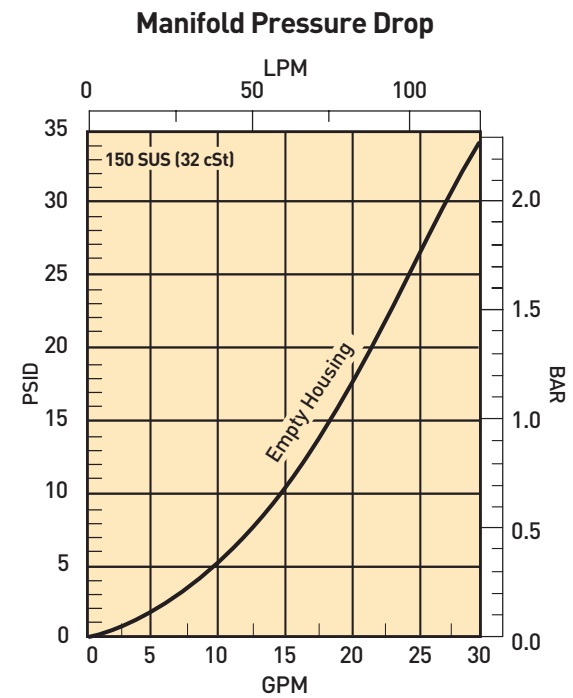
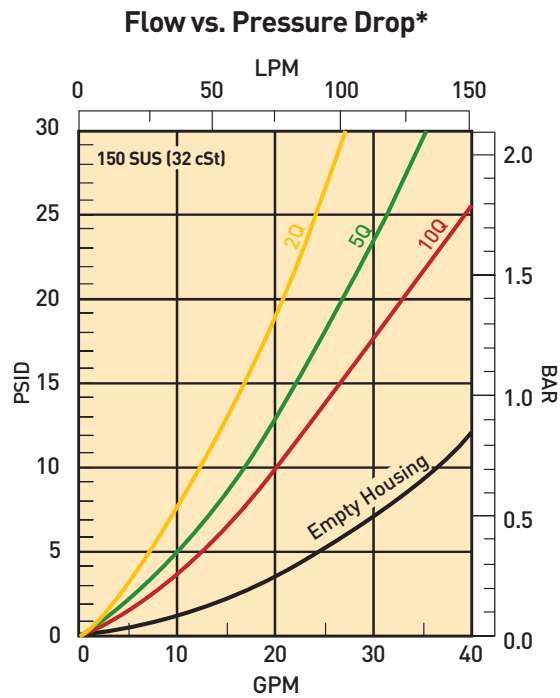
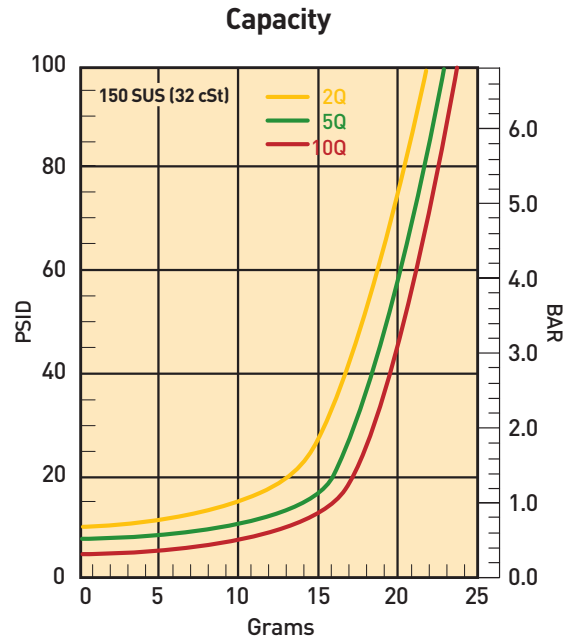
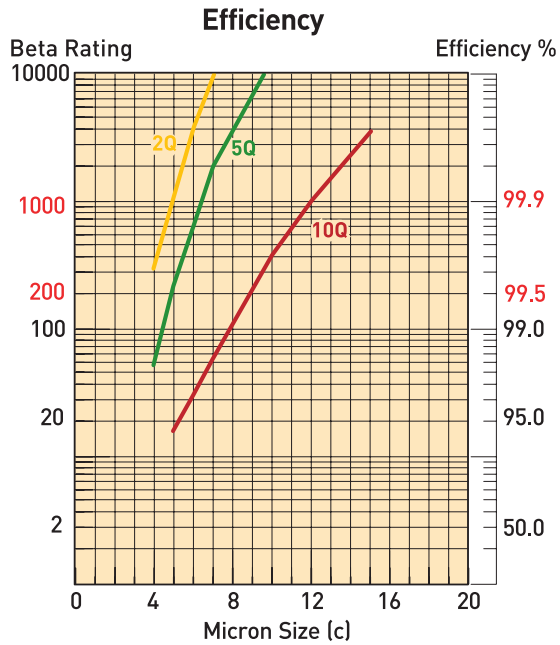

\*High Collapse Correction Factor:  
 "QH" Elements (2000 psid) = 1.4 times reported loss

Results typical from Multi-pass tests run per test standard ISO 16889 @ 25 gpm to 50 psid terminal - 10 mg/L BUGL.

Note: During reverse flow,  $\Delta P$  is 20 psid at max. flow.

# WPF Series

## WPF3 Element Performance

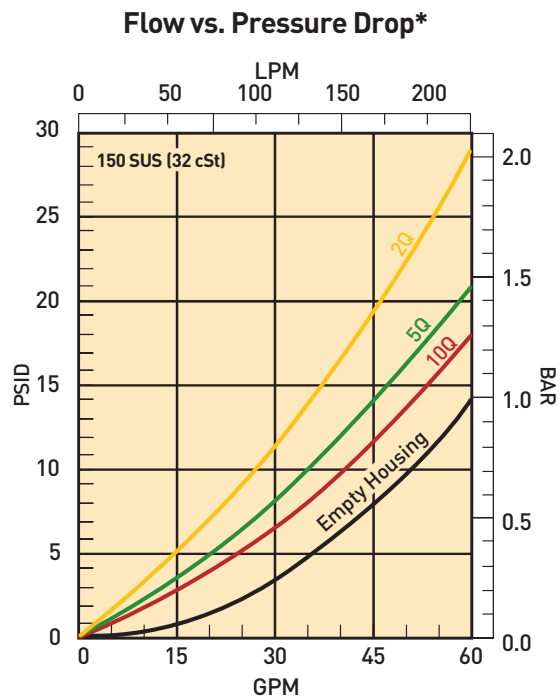
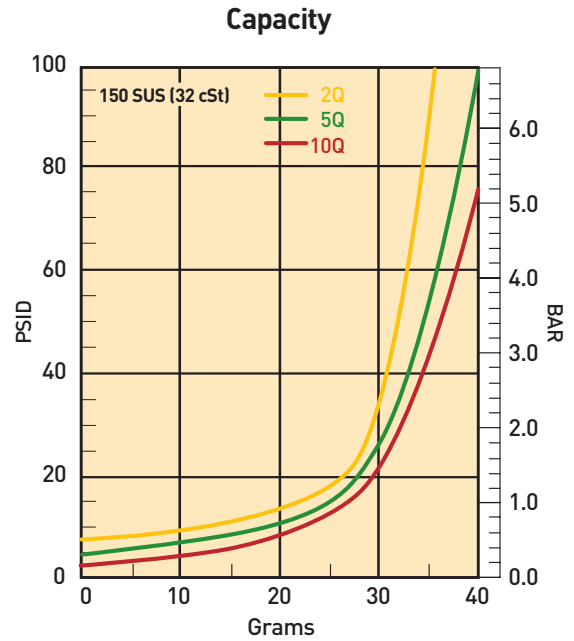
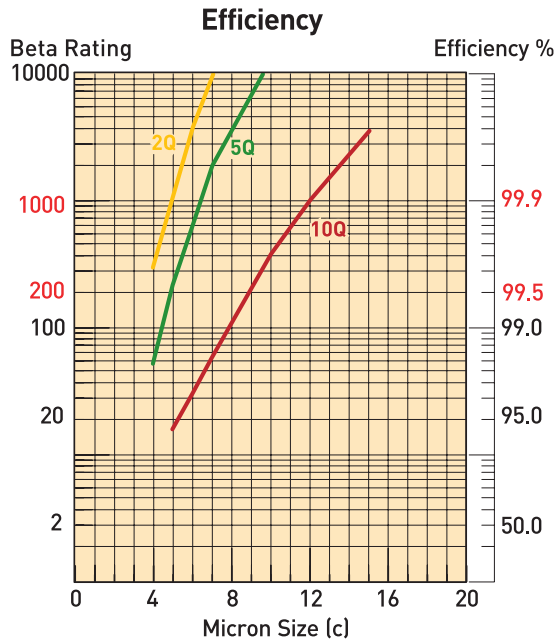

\*High Collapse Correction Factor:  
 "QH" Elements (2000 psid) = 1.4 times reported loss

Results typical from Multi-pass tests run per test standard ISO 16889 @ 45 gpm to 50 psid terminal - 10 mg/L BUGL.

Note: During reverse flow,  $\Delta P$  is 20 psid at max. flow.

# WPF Series

## WPF4 Element Performance

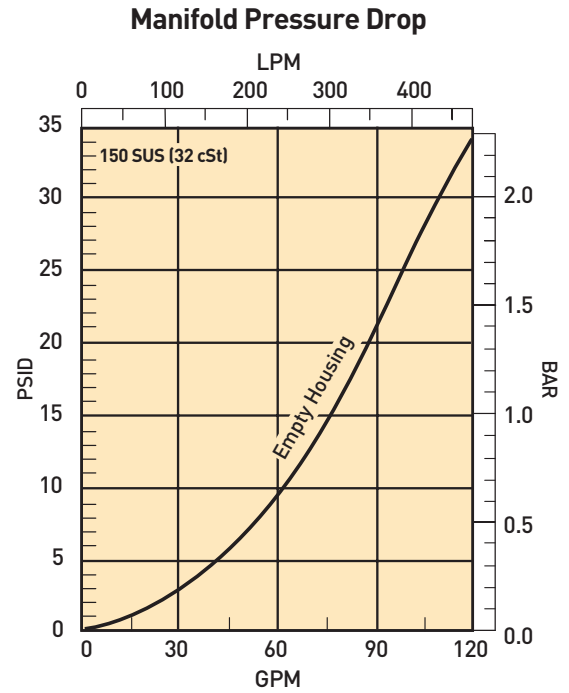
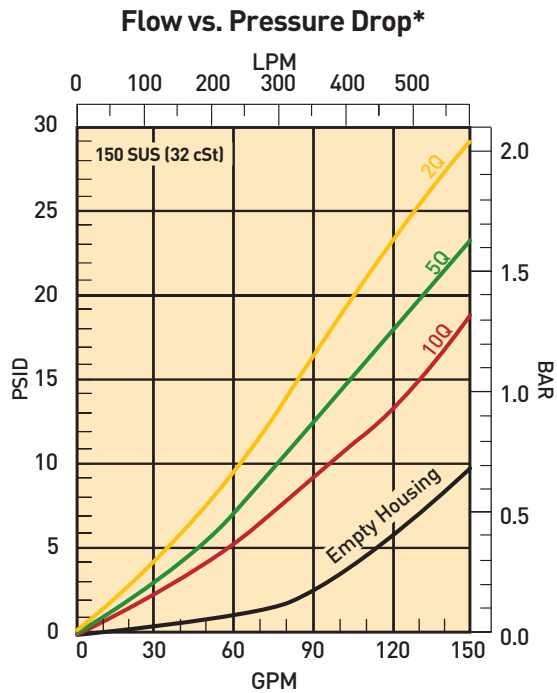
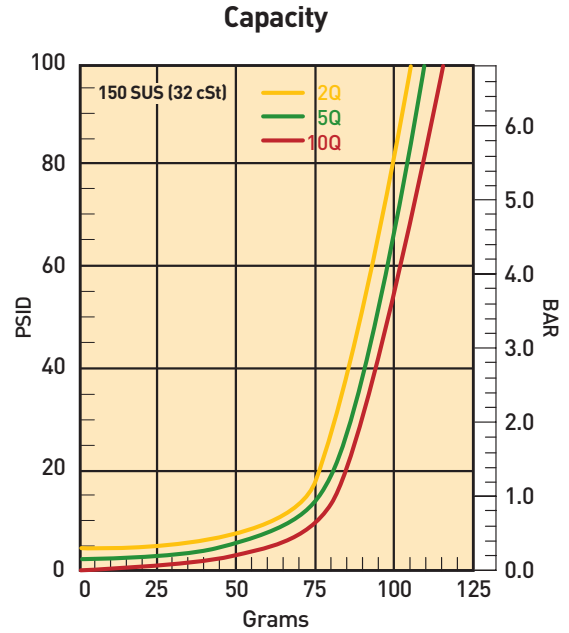
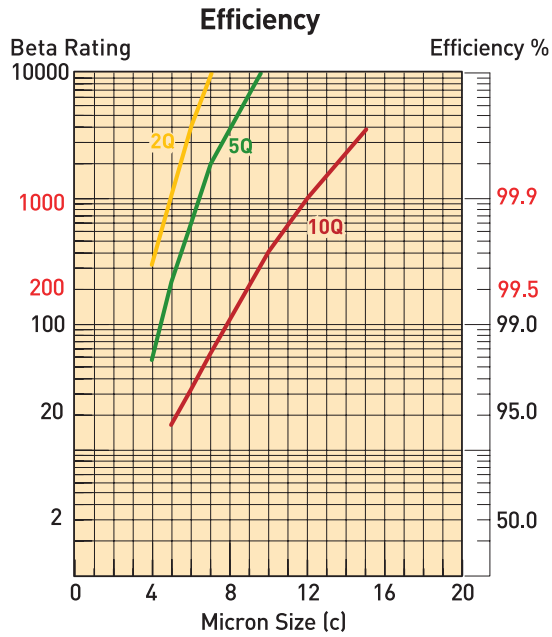

\*High Collapse Correction Factor:  
 "QH" Elements (2000 psid) = 1.4 times reported loss

Results typical from Multi-pass tests run per test standard ISO 16889 @ 90 gpm to 50 psid terminal - 10 mg/L BUGL.

Note: During reverse flow,  $\Delta P$  is 20 psid at max. flow.



# WPF Series

## WPF5 Element Performance

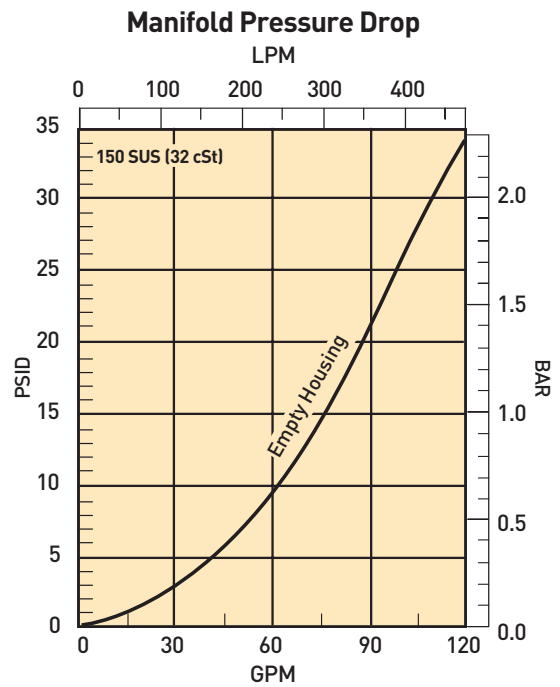
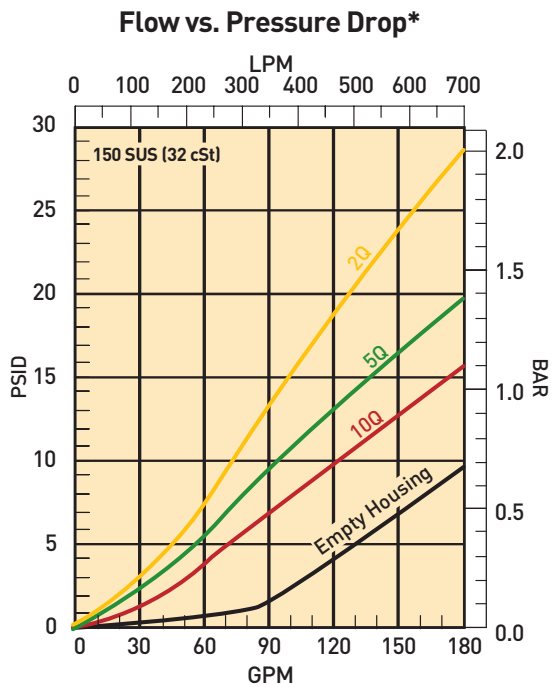
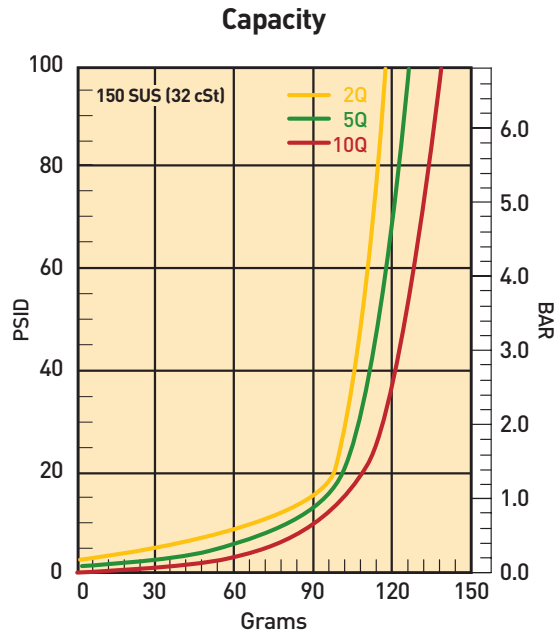
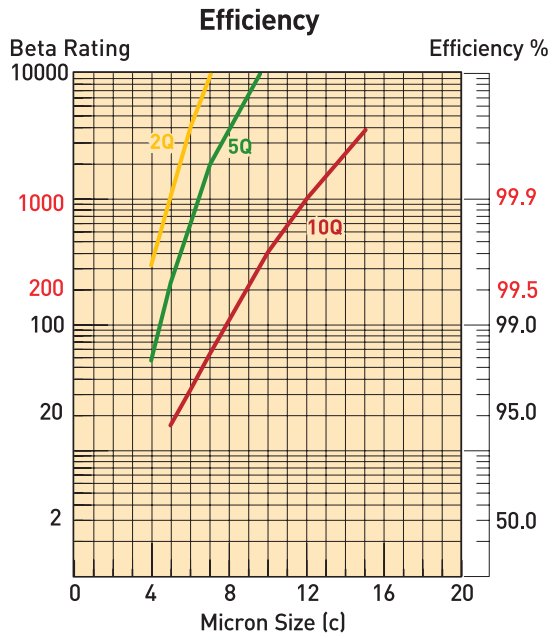

\*High Collapse Correction Factor:  
 "QH" Elements (2000 psid) = 1.4 times reported loss

Results typical from Multi-pass tests run per test standard ISO 16889 @ 100 gpm to 50 psid terminal - 10 mg/L BUGL.

Note: During reverse flow,  $\Delta P$  is 20 psid at max. flow.

# WPF Series

## Specifications

### Maximum Allowable Operating Pressure (MAOP):

7000 psi (483 bar)

### Rated Fatigue Pressure:

6000 psi (414 bar)

### Design Safety Factor: 3:1

### Operating Temperatures:

-15°F (-26°C) to 250°F (135°C)

### Element Collapse Rating:

Standard: 300 psi (21 bar)

High Collapse: 2000 psi (138 bar)

### Materials:

Head: SG Iron

Bowl: Steel

Indicator: Brass with

Plastic Connectors

### Weights:

WPF1 9 lbs. (4.1 kg)

WPF2 13 lbs. (5.9 kg)

WPF3 21 lbs. (9.5 kg)

WPF4 45 lbs. (20.4 kg)

WPF5 67 lbs. (30.4 kg)

Drawings are for reference only.  
Contact factory for current version.

## T-Port

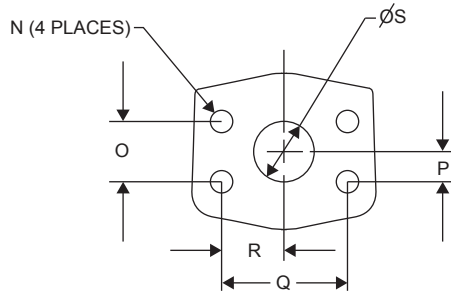
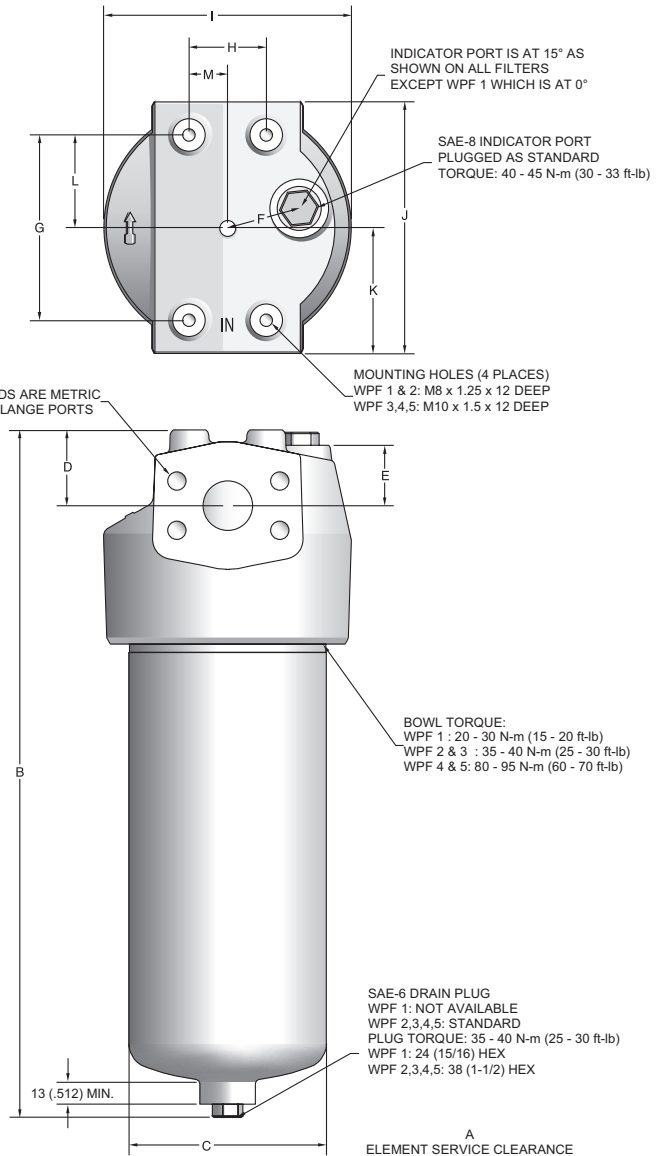

Flange Size	N: Thread & Depth	O	P	Q	R	S
3/4"	M10 x 1.5, 0.68"	.937"	.469"	2.000"	1.000"	.750"
1"	M12 x 1.75, 0.75"	1.093"	.546"	2.250"	1.125"	1.000"
1-1/4"	M14 x 2.0, 0.75"	1.250"	.625"	2.625"	1.312"	1.250"
1-1/2"	M16 x 2.0, 1.34"	1.437"	.719"	3.125"	1.563"	1.500"

### T-Port Dimensions (mm/inch)

Filter Model	A	B	C	D	E	F	G	H	I	J	K	L	M
WPF1	<u>70</u> 2.76	<u>180</u> 7.09	<u>69.5</u> 2.74	<u>23</u> .91	<u>15</u> .59	<u>27</u> 1.06	<u>60</u> 2.36	<u>30</u> 1.18	<u>90</u> 3.54	<u>92</u> 3.62	<u>46</u> 1.81	<u>30</u> 1.18	<u>15</u> .59
WPF2	<u>79</u> 3.11	<u>293</u> 11.53	<u>75</u> 2.95	<u>32</u> 1.26	<u>26</u> 1.02	<u>30</u> 1.18	<u>80</u> 3.15	<u>40</u> 1.57	<u>98</u> 3.86	<u>110</u> 4.33	<u>55</u> 2.17	<u>40</u> 1.57	<u>20</u> .78
WPF3	<u>88</u> 3.47	<u>345</u> 13.58	<u>93</u> 3.66	<u>40</u> 1.57	<u>29</u> 1.14	<u>35</u> 1.38	<u>90</u> 3.54	<u>55</u> 2.17	<u>120</u> 4.72	<u>126</u> 4.96	<u>63</u> 2.48	<u>45</u> 1.77	<u>27.5</u> 1.08
WPF4	<u>100</u> 3.94	<u>445</u> 17.52	<u>128</u> 5.04	<u>49</u> 1.93	<u>39</u> 1.54	<u>48</u> 1.89	<u>120</u> 4.72	<u>50</u> 1.97	<u>160</u> 6.3	<u>163</u> 6.42	<u>81.5</u> 3.21	<u>60</u> 2.36	<u>25</u> .98
WPF5	<u>100</u> 3.94	<u>561</u> 22.09	<u>128</u> 5.04	<u>61</u> 2.40	<u>51</u> 2.01	<u>48</u> 1.89	<u>140</u> 5.51	<u>80</u> 3.15	<u>160</u> 6.30	<u>183</u> 7.20	<u>91.5</u> 3.60	<u>70</u> 2.76	<u>40</u> 4.57

# WPF Series

## Specifications

### Maximum Allowable Operating Pressure (MAOP):

7000 psi (483 bar)

### Rated Fatigue Pressure:

6000 psi (414 bar)

### Design Safety Factor: 3:1

### Operating Temperatures:

-15°F (-26°C) to 250°F (135°C)

### Element Collapse Rating:

Standard: 300 psi (21 bar)

High Collapse: 2000 psi (138 bar)

### Materials:

Head: SG Iron

Bowl: Steel

Indicator: Brass with  
Plastic Connectors

### Weights:

WPF2 18 lbs. (8.2 kg)

WPF4 63 lbs. (28.6 kg)

WPF5 70 lbs. (31.7 kg)

Drawings are for reference only.  
Contact factory for current version.

### Manifold

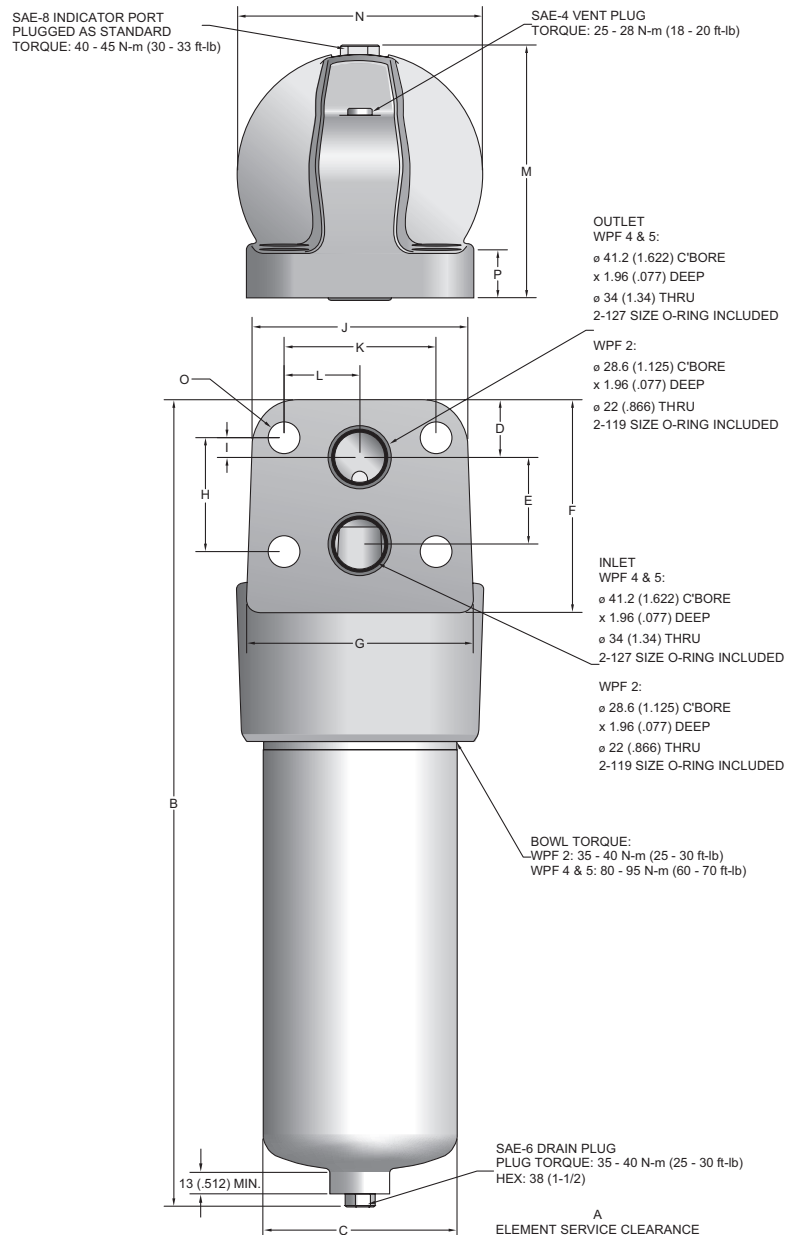

### Manifold Dimensions (mm/inch)

Filter Model	A	B	C	D	E	F	G	H	I	J	K	L	M	N	O	P
WPF2	79	343	75	24	39	95	116	50	6	110	80	40	110	121	17	30
	3.11	13.50	2.95	.94	1.53	3.74	4.57	1.97	.24	4.33	3.15	1.57	4.33	4.76	.67	1.18
WPF4	100	532	128	38	57	140	150	75	13	142	100	50	166.5	161	21	31.7
	3.94	20.94	5.04	1.50	2.24	5.51	5.91	2.95	.51	5.59	3.94	1.97	6.56	6.34	.83	1.25
WPF5	100	627	128	38	57	140	150	75	13	142	100	50	166.5	161	21	31.7
	3.94	24.69	5.04	1.50	2.24	5.51	5.91	2.95	.51	5.59	3.94	1.97	6.56	6.34	.83	1.25

# WPF Series

## Indicator Specifications

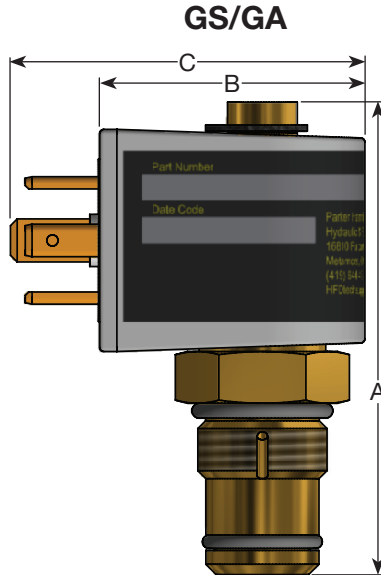

### GS

**Output:** Dry Contact Reed Switch

- Absolute maximum carry current 1 amp (AC/DC)
- Absolute maximum switching current 500 mA (AC/DC)
- Absolute maximum voltage 125 VAC/30 VDC

**Torque:** 30-35 ft lbs

### GA

**Output:** Analog 4-20 mA  
**Supply Voltage:** 10.0 VDC - 28 VDC (Clean and Filtered)

**Torque:** 30-35 ft lbs

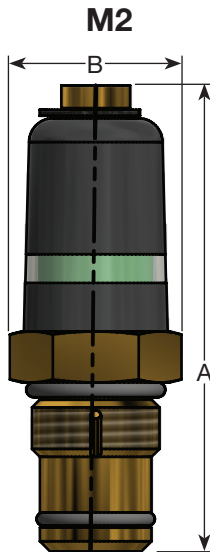
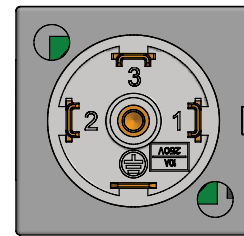

**Output:** Visual

### 947356

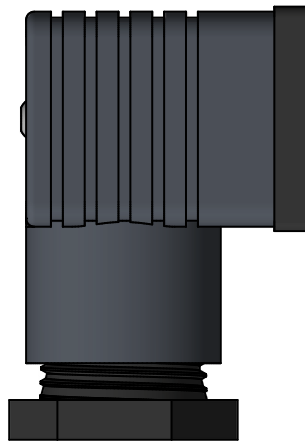

- DIN43650 standard socket
- For use with GS and GA

### 947355



- DIN43650 visual LED socket
- 12-35 VDC
- For use with GS

Option	Description	Connection/Power	Wiring	A B C		
				inches/mm		
GS	Reed Switch	DIN 43650 3 Pole + Earth 500mA @ 30 VDC 500mA @125 VAC	Pin 1 - Common Pin 2 - Normally Open Pin 3 - Normally Closed Pin 4 - Not Connected	2.74 69.6	1.54 39.1	2.06 52.3
GA	4-20mA Analog	DIN 43650 3 Pole + Earth Supply Voltage: 10 VDC - 28 VDC Output: 4-20 mA	Pin 1 - Supply (10VDC - 28VDC) Pin 2 - Common (Circuit Ground) Pin 3 - 4-20mA Out Pin 4 - Not Connected	2.74 69.6	1.54 39.1	2.06 52.3
M2	Visual	N/A	N/A	2.74 69.6	1.45 36.8	N/A

# WPF Series

## Service & Maintenance Instructions

1 Stop system power and vent captive pressure.

2 Drain filter assembly.

3 Remove bowl and element assembly.

4 Push down to squeeze tangs and lift element.

5 Twist to remove core.

6 Retain reusable core.

7 Discard used element.

8 Insert reusable core into new element until it snaps.

9 Push element assembly into bowl, snap tangs.

10 Inspect o-ring and anti-extrusion ring.

11 Install bowl with new element.

12 Torque bowl, vent and drain plugs.

13 Power up and inspect.



# WPF Series

## Parts List

### T-port

Index	Part Description	Part Number
1	WPF1 Head SAE-8	940986
	WPF2 Head 3/4" Flange	940989
	WPF2 Head SAE-12	940988
	WPF3 Head 1" Flange	940992
	WPF3 Head SAE-16	940991
	WPF4 Head 1-1/4" Flange	940923
	WPF4 Head SAE-20	940924
	WPF5 Head 1-1/2" Flange	940773
	WPF5 Head SAE-24	940921
2	Element See chart on How to Order page	
3	WPF1 Reusable Core	941175
	WPF2 Reusable Core	941176
	WPF3 Reusable Core	941177
	WPF4 Reusable Core	941178
	WPF5 Reusable Core	941179
4	WPF1 Bowl O-ring	V92141
	WPF2 Bowl O-ring	V92144
	WPF3 Seal Kit <sup>1</sup> FKM	947535
	WPF4 Bowl O-ring	V92157
	WPF5 Bowl O-ring	V92157
5	WPF1 Anti-extrusion Ring	941185
	WPF2 Anti-extrusion Ring	934798
	WPF4 Anti-extrusion Ring	941187
	WPF5 Anti-extrusion Ring	941187
6	WPF1 Bowl	942269
	WPF2 Bowl	942299
	WPF3 Bowl	945767
	WPF4 Bowl	941156
	WPF5 Bowl	941157
7	Drain Plug	934320
8	Indicator Plug	941172
9	50psi Visual Indicator	945661
9	50psi Visual Indicator EPR	947292
10 <sup>2</sup>	50psi Electrical Reed Switch Indicator	946201
10 <sup>2</sup>	50psi Electrical Reed Switch Indicator - EPR	947288
10 <sup>2</sup>	50psi Analog 4-20mA Indicator	946210
10 <sup>2</sup>	50psi Analog 4-20mA Indicator - EPR	947289
Not Shown <sup>2</sup>	Standard DIN 43650 Socket Kit	947356
Not Shown <sup>2,3</sup>	12-35VDC LED Visual DIN 43650 Socket	947355
11	Name Plate	920928
Not Shown	Drive Screw (2 required)	900028

1. 947536 includes o-ring and anti-extrusion ring.
2. Indicator and DIN43650 socket sold separately.
3. For use with 946201 and 947288.

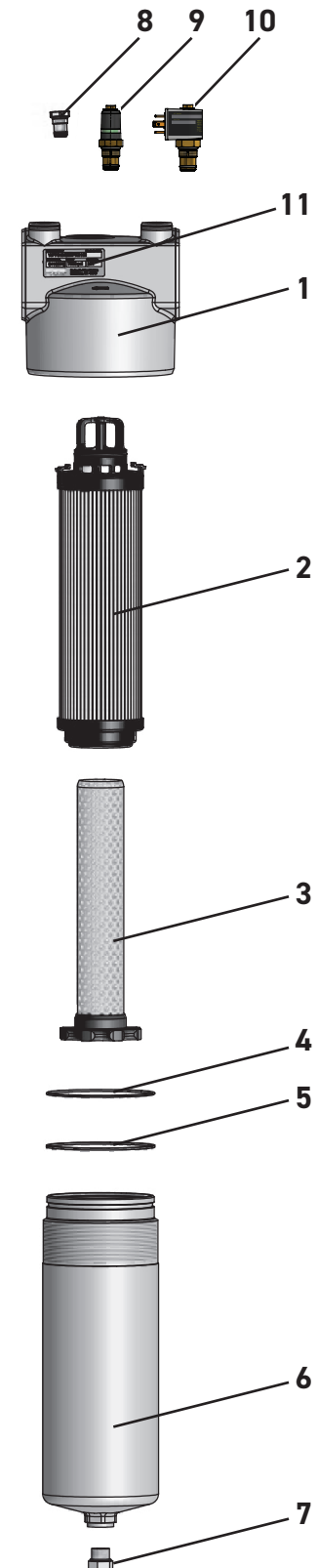

# WPF Series

## Parts List

### Manifold

Index	Part Description	Part Number
1	WPF2 Manifold Mount Head	941273
	WPF4 Manifold Mount Head	940982
	WPF5 Manifold Mount Head	940982
2	WPF2 Manifold Mount O-rings (2 req'd)	V92119
	WPF4 Manifold Mount O-rings (2 req'd)	V92127
	WPF5 Manifold Mount O-rings (2 req'd)	V92127
3	Element See chart on page 153	
4	WPF2 Reusable Core	941176
	WPF4 Reusable Core	941178
	WPF5 Reusable Core	941179
5	WPF2 Bowl O-ring	V92144
	WPF4 Bowl O-ring	V92157
	WPF5 Bowl O-ring	V92157
6	WPF2 Anti-extrusion Ring	934798
	WPF4 Anti-extrusion Ring	941187
	WPF5 Anti-extrusion Ring	941187
7	WPF2 Bowl	942299
	WPF4 Bowl	941156
	WPF5 Bowl	941157
8	Drain Plug	934320
9	Vent Plug	928882
10	WPF Indicator Plug	941172
11	50psi Visual Indicator	945661
11	50psi Visual Indicator EPR	947292
12 <sup>1</sup>	50psi Electrical Reed Switch Indicator	946201
12 <sup>1</sup>	50psi Electrical Reed Switch Indicator - EPR	947288
12 <sup>1</sup>	50psi Analog 4-20mA Indicator	946210
12 <sup>1</sup>	50psi Analog 4-20mA Indicator - EPR	947289
Not Shown <sup>1</sup>	Standard DIN 43650 Socket Kit	947356
Not Shown <sup>1,2</sup>	12-35VDC LED Visual DIN 43650 Socket	947355
Not Shown	Name Plate	920928
Not Shown	Drive Screw (2 required)	900028

1. Indicator and DIN43650 socket sold separately.

2. For use with 946201 and 947288.

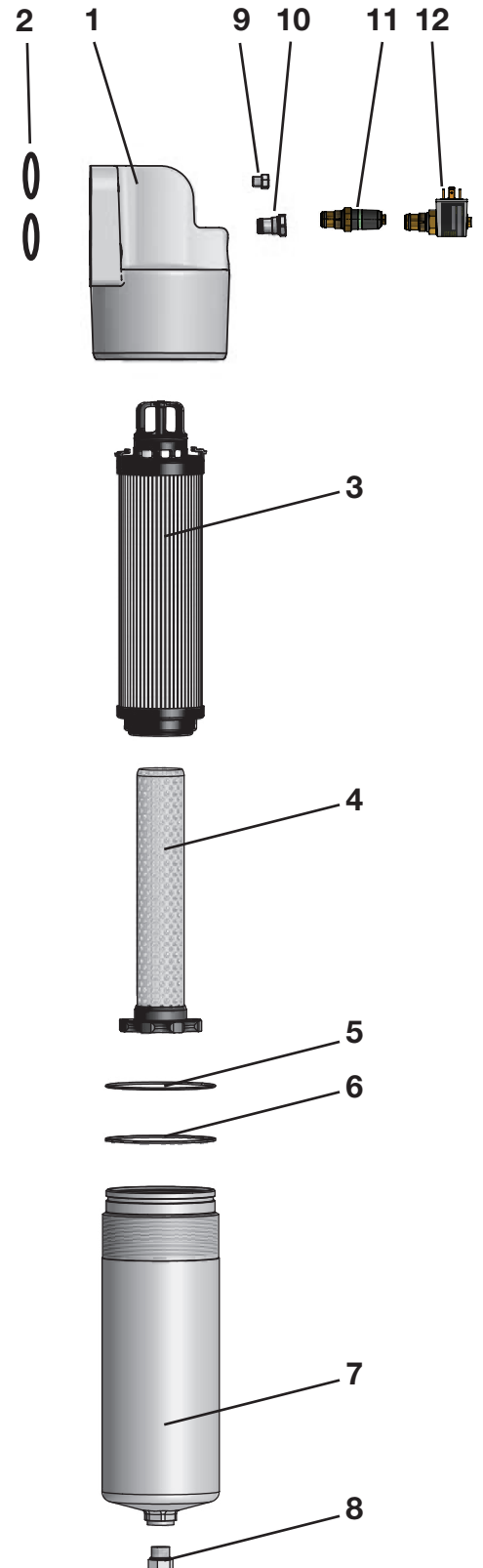

# WPF Series

## High Pressure Filters

### How To Order

Select the desired symbol (in the correct position) to construct a model code.

Example:

BOX 1	BOX 2	BOX 3	BOX 4	BOX 5	BOX 6	BOX 7	BOX 8
WPF	2	10QE	V	M2	K	S12	1

BOX 1: Filter Series	
Symbol	Description
WPF	High Pressure Filter

BOX 2: Element Length	
Symbol	Description
1	1/2" Nominal ports
2	3/4" Nominal ports
3	1" Nominal ports
4	1 1/4" Nominal ports
5	1 1/2" Nominal ports

BOX 3: Media Code	
Symbol	Description
	Standard Element (bypass only)
02QE	Microglass, 2 micron
05QE	Microglass, 5 micron
10QE	Microglass, 10 micron
	High Collapse (no-bypass only)
02QH	Microglass, 2 micron
10QH	Microglass, 10 micron

BOX 4: Seals	
Symbol	Description
B	Nitrile
E	Ethylene Propylene
V	Fluorocarbon

BOX 5: Indicators <sup>1</sup>	
Symbol	Description
P	Plugged indicator port
M2	50psi Visual
GS <sup>2</sup>	50psi Electrical Reed Switch with DIN 43650 socket
GA	50psi Analog 4-20mA with DIN 43650 socket

Notes:  
1. When the "M2", "GS" and "GA" option is selected, the indicator port is plugged and the indicator is shipped as a loose part.

2. Visual LED DIN 43650 socket available see parts list

BOX 6: Bypass & Indicator Setting	
Symbol	Description
K	50 psid (3.5 bar)
X	No bypass & No indicator (port plugged)

Note: When an indicator and no bypass ("2" in Box 8) is selected, the indicator setting is 50 psid (3.5 bar).

BOX 7: Ports	
Symbol	Description
	WPF1
S08	SAE-8
	WPF2
S12	SAE-12
Y12 <sup>1</sup>	3/4" SAE code 62 flange face
X12	Manifold
	WPF3
S16	SAE-16
Y16 <sup>1</sup>	1" SAE code 62 flange face
	WPF4
S20	SAE-20
Y20 <sup>1</sup>	1 1/4" SAE code 62 flange face
X20	Manifold
	WPF5
S24	SAE-24
Y24 <sup>1</sup>	1 1/2" SAE code 62 flange face
X24	Manifold

BOX 8: Options	
Symbol	Description
1	Bypass (standard element only)
2	No bypass (high collapse element only)

Notes:

1. Threads are metric for flange ports.

### Replacement Elements

	Media	WPF1	WPF2	WPF3	WPF4	WPF5
Standard Collapse 300 psid (21 bar)	Microglass, 02QE	941029Q	941032Q	941035Q	941038Q	941041Q
	Microglass, 05QE	941030Q	941033Q	941036Q	941039Q	941042Q
	Microglass, 10QE	941031Q	941034Q	941037Q	941040Q	941043Q
High Collapse 2000 psid (138 bar)	Microglass, 02QH	941044Q	941046Q	941048Q	941050Q	941052Q
	Microglass, 10QH	941045Q	941047Q	941049Q	941051Q	941053Q